

Hansen Industrial Transmissions: powerful drive solutions

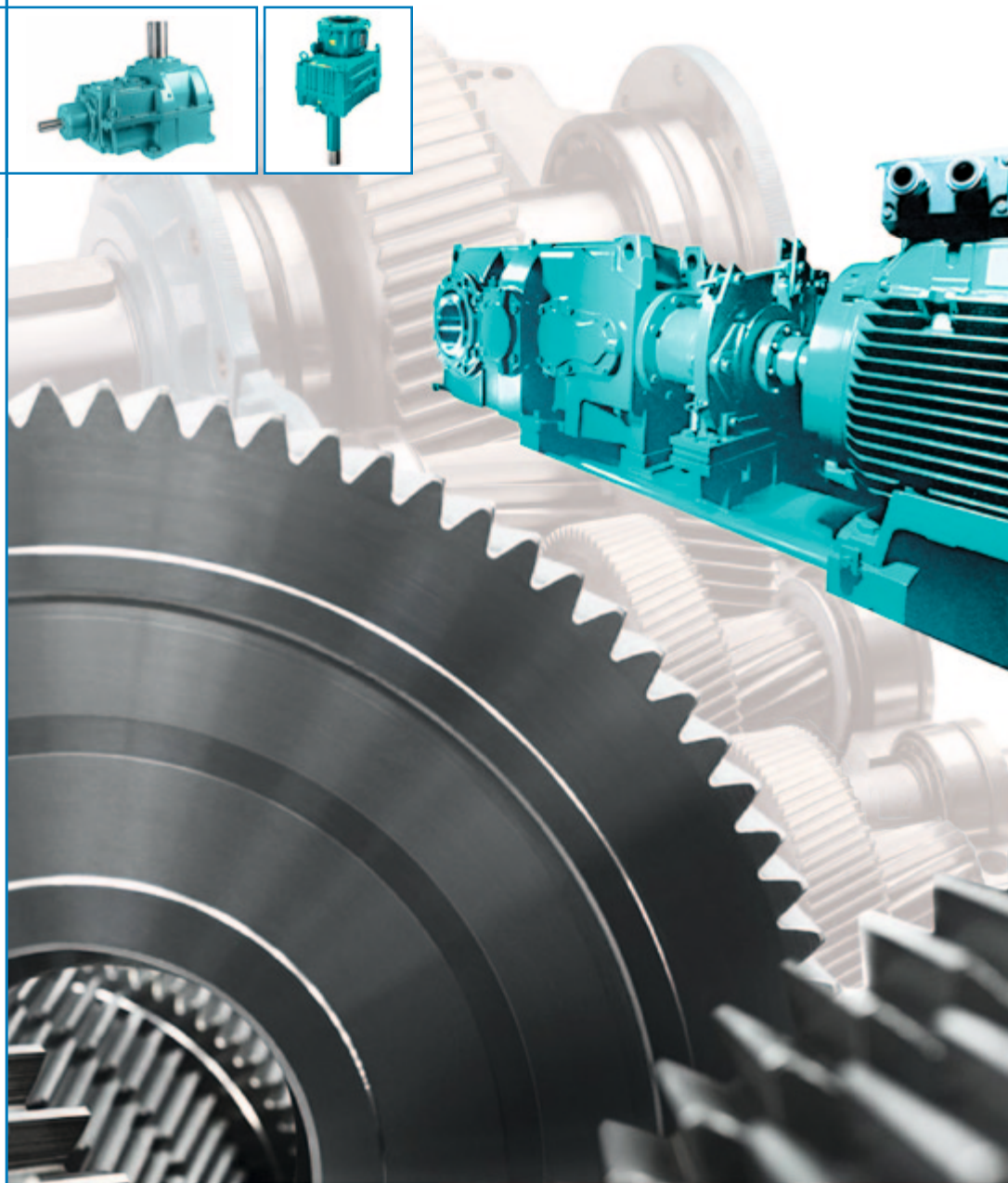
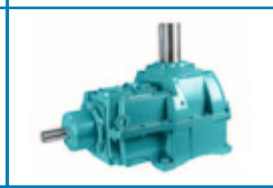
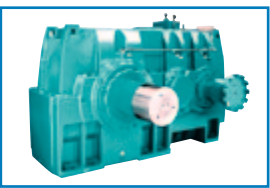

| i n g e a r f o r

Our mission:
In Gear For Your Success

Driven by gear technology, Hansen Industrial Transmissions fulfils the needs of its global customer base by offering them reliable mechanical power transmission solutions for demanding industrial applications.



y o u r s u c c e s s

Dear reader,

Since 1923, Hansen Industrial Transmissions nv has been at the forefront of power transmission technology. We have grown to become a world leading manufacturer of industrial gear units and a supplier of complete drive solutions from grid connection to machine shaft for a wide variety of applications in a broad range of industries.

Our main product line, the Hansen P4 range, excels in low noise, minimum weight and features numerous other characteristics answering our customer needs and complying with today's standards of durable and efficient mechanical drive solutions.

Worldwide, our skilled staff and business partners are in gear for your success, offering a wealth of experience and expertise, the result of years of close and interactive co-operation with a distinguished record of customers.

Our complete portfolio of products and drive solutions is reflected in this brochure. I hereby also invite you to find out how you can benefit from our experience and expertise, either through our website or by contacting your nearest Hansen Industrial Transmissions sales centre.



*Torsten Schultz
Managing Director
Hansen Industrial Transmissions nv*



In the late 1940's, any company producing industrial transmission drive systems was faced with a problem that at the time seemed insoluble. No company had succeeded in standardizing the production of gear units. Expensive, custom-made solutions – time-consuming to produce, assemble and maintain – were the norm.

David Hansen, however, was a born innovator, who tackled the problem through original thinking based on scientifically researched concepts. The result, launched in 1950, was the Hansen Patent-I – a revolutionary new concept for the design and manufacture of standard gear units. As David Hansen himself was able to say with understandable pride:

"The Hansen Patent-I speed reducer constitutes an original and complete answer to the problem of standardization, meeting the requirements of application selling, mass production, quality and competitive prices."

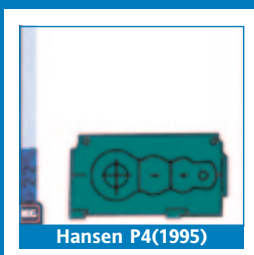

Hansen P4(1995)

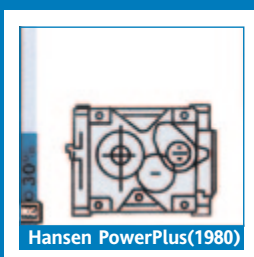

Hansen PowerPlus(1980)

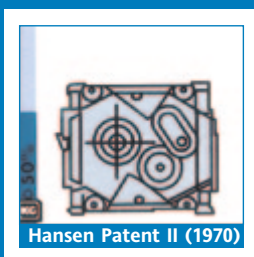

Hansen Patent II (1970)

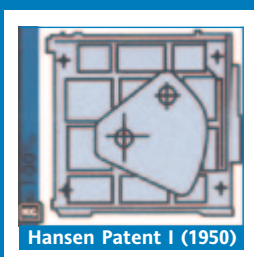

Hansen Patent I (1950)

1923



Moving from customized to serial manufacture led to a number of important benefits:

- Production costs were reduced.
- Improved quality control procedures could be implemented.
- The number of spare parts was reduced.
- Delivery times were slashed.

Gear units were never the same again as other manufacturers followed our lead. Since then we have consistently been at the forefront of transmission technology.

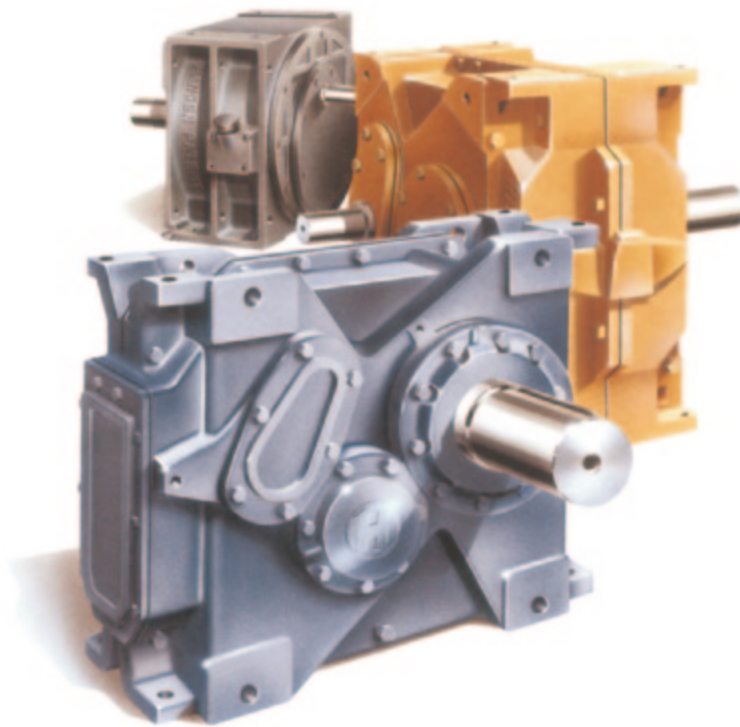

Hansen Patent I (1950)

Hansen Patent II (1970)

Hansen PowerPlus(1980)

■ HANSEN PATENT-I

Common gear sets allowed Hansen Patent-I gear units to be inter-related, as one size of gear unit determined the preceding and following sizes. This is expressed in the "law of centre distances", a principle which is still applied today in the latest Hansen industrial gearboxes.

■ HANSEN PATENT-II

In 1970 the product line was re-evaluated to respond to changing market requirements and to take advantage of new technologies such as improved hardening and grinding techniques. Based on the Hansen Patent-I principles of standardization of housings and gearings, Hansen Patent-II established new standards with the concept of market adequacy of the torque scale.

The launch of Hansen Patent-II confirmed our position as the worldwide leader in industrial transmission drive systems.

■ HANSEN POWERPLUS

By 1980 the company took another step ahead of the competition. The objective was to incorporate new technologies and achieve the highest performance and reliability in this area. Emphasis was placed on the introduction of new rigid housings, in line with the high stiffness requirements for load distribution and low noise behaviour.

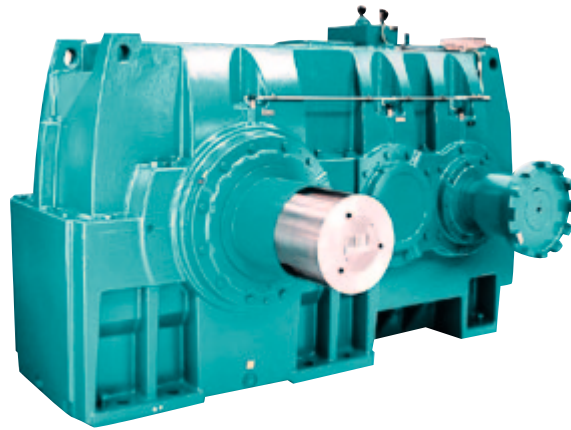

Hansen P4

single & multi-stage gear units

The P4 range excels in low noise and vibration levels as well as in minimum weight: for a given output, a Hansen P4 is just one-fifth of the weight of its 1950 ancestor. Hansen P4 multi-stage units come in 19 sizes from 6 to 1100 kNm. The Hansen P4 single stage range caters for 5 sizes in two mounting positions for mechanical powers from 100 kW up to 4 MW.

Hansen P4 (1995)

"Compliance with application requirements"

The launch of the Hansen P4 range in 1995 revealed new standards in how gear units are matched to the market applications: simplified product selection; gear units fine-tuned to specific applications; accessories more easily integrated; special features included as standard.

"An innovative approach to user-friendliness"

Through creative industrial design techniques, lower noise levels, 100% oil-tightness (Oil-Lock™ as a new standard), easy handling and simplified maintenance procedures were established.

"A balanced line-up of components for excellence in service"

Reduced number of pinion shafts; fewer spare parts; standardized components; proven well-

Hansen P4 single stage (1999)

known brands for accessories created a greater availability of spare parts and unparalleled commitment to customer service.

"Power and reliability through quality and technology"

State-of-the-art technology resulted in the most powerful gear units available today. Development and manufacturing according to ISO 9001 standards leads to quality in all aspects.

To complement its current range of standardized multi-stage gear units, Hansen Industrial Transmissions introduced an innovative range of single stage gear units for various applications requiring small reduction ratios: e.g. paper machines, pumps, compressors, etc.



Hansen M4 ACC

monobloc gear units

The Hansen M4 ACC product line is available in 6 sizes within an output torque range from 20000 to 70000 Nm and a wide range of reduction ratio's.

Hansen M4 ACC (2004)

The new range of single stage gear units has been designed from scratch: every existing multi-stage dogma has been questioned, alternatives have been developed and evaluated.

A typical example of this approach is the use of variable centre distances in a given housing size. In "traditional" designs, with fixed centre distance and torque rating, the reduction ratio of a single stage gear unit has a major effect on the power rating. This means that for small reduction ratios, very large powers can be transmitted, which may lead to thermal limitations. At the other end, for large ratios, gear casings become oversized for the transmitted power. For a given size of unit this leads to inefficient compromises on bearing selection and mechanical and thermal rating.

More than 2500 of the Hansen M4 ACC gear units are successfully operating air cooled condensers in energy generation plants in the main markets worldwide.

Its dedicated design has been developed in close cooperation with customers of Air Cooled Condensers, a technical high demanding application. It makes use of the very latest in gear technology and gear unit design. Major interest has been paid to the reliability and user friendliness of these gear units by using our extensive in-house experience. The Hansen M4 ACC range excels in low noise and gearing performance by using the second to none Hansen P4 gear technology.

The Hansen M4 ACC monobloc range is designed to comply with the Standard Cooling Tower Institute specifications for gearboxes. Its helical gears are designed and rated in accordance with AGMA for maximum load capacity, minimum losses and quiet operation. The low speed shaft bearings are selected to allow considerable thrust loads. The heat generated in the gearbox due to losses can be dissipated by natural cooling through the housing or additional fan cooling. The low speed shaft has a regreasable labyrinth and a drywell construction. The built-in backstop (optional) prevents the cooling tower fan from "windmilling". The backstop is accessible after removing the motor and lantern housing.

our product features

your benefits

Hansen P4

MULTI-STAGE GEARBOXES

VERTICAL APPLICATIONS

HORIZONTAL APPLICATIONS

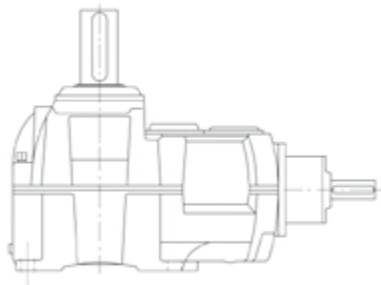

2
Stage

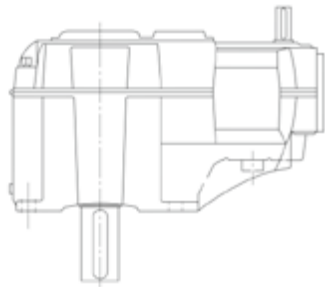
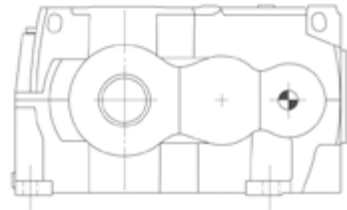

3
4
Stage

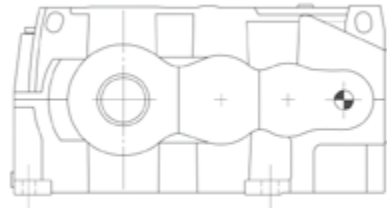

Size	Centre distance																				kNm	
	y	z	a	b	c	d	e	f	g	h	j	k	l	m	n	p	q	r	s	t		u
A	●		●																			6
B		●		●																		9
C	●		●		●																	15
D	●	●		●		●																23
E	●		●		●		●															35
F		●		●		●		●														53
G			●		●		●		●													75
H			●		●		●		●													100
J				●		●		●		●												130
K				●		●		●		●												170
L					●		●		●		●											230
M					●		●		●		●											290
N						●		●		●		●										350
P						●		●		●		●										420
Q						●		●		●		●										500
R							●		●		●		●									600
S							●		●		●		●									700
T							●		●		●		●									800
U							●		●		●		●									1100



FITNESS FOR USE

With the Hansen P4 product line you can easily select what you need, thereby optimizing your investment.

■ FEATURE	■ YOUR BENEFIT
■ Specific housings for horizontal and vertical applications	■ Easy to select the optimal gear unit for a specific application - value for money
■ Standard higher bearing span for vertical applications	■ Stronger shaft support for surface aerators, mixers...
■ Simple, standard systems for cooling and lubrication	■ Proven and cost-effective solutions
■ Accessories and instrumentation are offered as catalogue options	■ Easy and fast customization possibilities
■ Improved component standardization	■ Shorter delivery times
■ Special ratios up to 1% of the requested ratio at moderate cost	■ Cost efficient tailor-made solution

INSTALLATION

Even the larger Hansen P4 models are easy to transport, manoeuvre and install.

■ FEATURE	■ YOUR BENEFIT
■ Provision for crowbar or adjusting screws, oval transport slots or hoist eyes & standard fixation points for accessories	■ Easy installation procedure; easy to handle, install and to mount accessories such as protection caps
■ Internal construction ensures oil supply to all bearings on first oil filling	■ Bearings safely lubricated from the start
■ Large mounting pads can accommodate extra dowel pins	■ Easy realignment

POWER & RELIABILITY

The excellent constructional rigidity of Hansen P4, together with the commitment to apply state-of-the-art gear technology, leads to remarkable power and performance

■ FEATURE	■ YOUR BENEFIT
■ Rigid, standardized pinion shafts and housings	■ Better lateral load distribution, lower noise and vibration levels
■ Full-scale application of: <ul style="list-style-type: none"> ■ High torque geometry in low speed gear sets ■ Low noise geometry in high speed gear sets ■ Profile-controlled gas carburizing ■ Precision grinding with sophisticated tooth contact analysis 	<ul style="list-style-type: none"> ■ Better strength/surface durability rating balance ■ Lower noise and vibration levels ■ Optimal load capacity ■ Optimal transverse and lateral load distribution, lower noise and vibration levels
■ Assured oil circulation through the bearings	■ Long, troublefree working life

SPARE PARTS, SERVICE & MAINTENANCE

The Hansen P4 is one of the easiest to maintain gear units on the market. The maintenance operation itself has been simplified and shortened.

■ FEATURE	■ YOUR BENEFIT
■ Housings for horizontal and vertical applications both with horizontal split	■ Easy to open for inspection and service on-the-spot
■ Maintenance-free Oil-Lock™ seal as a standard on the high speed shaft extensions	■ Oil-tight for life - no maintenance required
■ Drywell standard for vertically down shaft	■ Oil-tight for life
■ Easy to remove inspection cover with O-seal above the oil level	■ Easy and quick inspection without oil drainage
■ Provision for easy removal of covers	■ Easy to open for service on-the-spot
■ Specific housings for horizontal and vertical applications	■ Total oil evacuation possible
■ Rounded external design	■ Smooth surface without dirt-retaining cavities

Hansen P4 SINGLE STAGE GEARBOXES

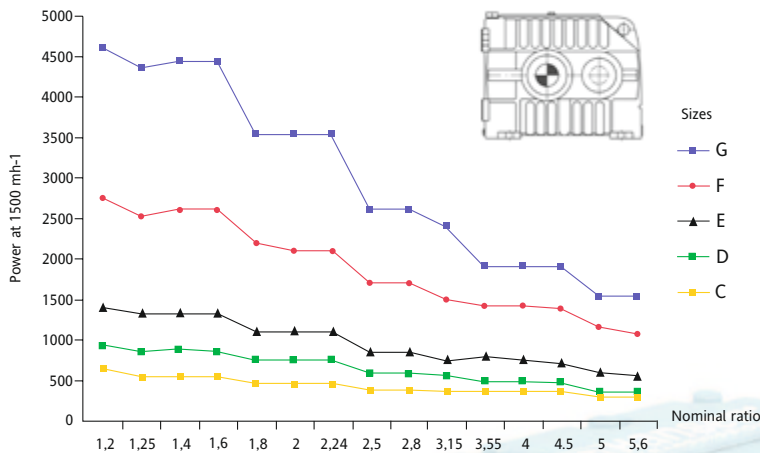

FITNESS FOR USE

FEATURE	YOUR BENEFIT
Simple, standard systems for cooling and lubrication	Proven and cost-effective solutions
Accessories and instrumentation are offered as catalogue options	Easy and fast customization possibilities
Two mounting positions and alternative mounting with both shafts in a vertical plane	Increased flexibility in mounting arrangements
Left hand execution equals right hand execution	Easy change of shaft handing, and only one spare unit needed for both
Enlarged though compact housing and increased shaft height	The input shaft height matches the large motor shaft height even better
Variable centre distances	Easy replacement and improvement of existing installations at a minimum effort and cost
Improved component standardization	Shorter delivery times
Special ratios up to 1% of the requested ratio at moderate cost	Cost efficient Tailor-made solution

SPARE PARTS, SERVICE & MAINTENANCE

FEATURE	YOUR BENEFIT
Maintenance-free Oil-Lock™ seal as a standard on the high speed shaft extensions	Oil-tight for life - no maintenance required
Rounded external design	Smooth surface without dirt-retaining cavities

POWER & RELIABILITY

FEATURE	YOUR BENEFIT
Rigid, standardized pinion shafts and housings	Better lateral load distribution, lower noise and vibration levels
Full-scale application of: <ul style="list-style-type: none"> High torque geometry in low speed gear sets Low noise geometry in high speed gear sets Profile-controlled gas carburizing Precision grinding with sophisticated tooth contact analysis 	<ul style="list-style-type: none"> Better strength/surface durability rating balance Lower noise and vibration levels Optimal load Capacity Optimal transverse and lateral load distribution, lower noise and vibration levels
Assured oil circulation through the bearings	Long, troublefree working life
Optimal balance between mechanical, thermal and bearing rating	Size is equivalent to power, resulting in optimal performance and efficiency for all ratios
Specific macro gear geometry	Reduced power losses Lower noise & vibration levels Reduced operating costs
Tapered roller bearings in the monolithic housing	Ideal absorption of high internal gear forces
Increased shaft height	Motor & gear unit equally affected by thermal expansion

FEATURE	YOUR BENEFIT
Oversized inspection cover on top of the gear unit	Easy to open for service or inspection or to replace taper roller bearings

Our technology: innovative & sustainable

Hansen P4

■ NOISE AT A MINIMUM

Minimal noise contributes to the comfort of the workplace and is therefore an important criterion when selecting industrial gear units. The Hansen P4 is designed to generate as little noise as possible; the basic design rules guarantee maximum stiffness of all gear unit components under load. Together with the most rigid pinion shafts and housings, the gear units transmit exceptional high power and a minimum of noise. Standard manufacturing processes help to minimize noise: precise machining of the housing on advanced CNC machines guarantees that the bores of the gear units are exact; an imperative for optimal gear mesh. Precision grinding of the gears and adapted gear geometry in the high-speed gear sets diminishes vibration levels; this 'low noise geometry' is applied to both bevel and helical gears.

■ FIRM ON ITS FEET

The rigid gear casing design of the Hansen P4 series maintains a correct gear alignment. The vertical P4 housing has been designed to ensure smooth transition of forces from the centre bore to the mounting feet, which are positioned concentric to the low speed shaft. An important feature for e.g. mixers and agitators or surface aerators.

■ INTEGRATED DRYWELL

The integrated drywell is a standard feature for all vertical Hansen P4 gear units (output shaft ↓). It guarantees oil-tightness for life. A highly appreciated feature in many industries, including food processing and water treatment.

■ NEVER A DRY START-UP

Centralized oil filling in Hansen P4 gear units guarantees initial oil lubrication and circulation through all bearings, thus avoiding any risk of a dry start-up. This results in minimized wear on the bearings, simplified overall maintenance and a longer bearing life.

■ 100% OIL TIGHT

Our unique Oil-Lock™ system offers a maintenance free seal on high speed shaft extensions, and is standard on all Hansen P4 units. It is designed to keep the oil in and dirt out and is the most secure high speed shaft sealing solution available, which has proven its effectiveness on thousands of Hansen P4 gear units. For tilted or inclined operation, we provide a unique Oil-Guard™. It consists of a tapered ring, rotating close to the machined housing and functioning as a centrifugal pump. It is located between the oil and a radial seal. During operation, even in submerged conditions, our Oil-Guard™ ensures leak free running conditions.

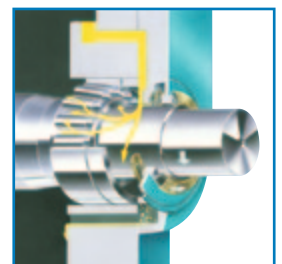
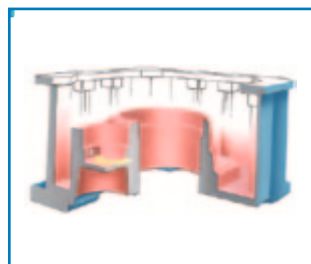
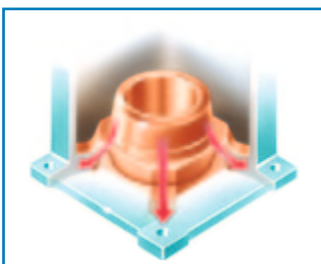

application focused



■ AIR COOLED CONDENSERS

Dry cooling tower drives

Brochure: Ref. 603
Catalogue: Ref. 604



■ COOLING TOWERS

Wet cooling tower drives

Brochure: Ref. 603
Catalogue: Ref. 604



■ WATER TREATMENT

Common aerators
Brush aerators
Carrousel aerators
Screw pumps ...

Brochure: Ref. 605
Catalogue: Ref. 606



■ MATERIAL HANDLING

Conveyors
Bucket elevators
Travel drives ...

Brochure: Ref. 612
Catalogue: Ref. 615



■ MIXERS & AGITATORS

Chemical industry
Petro-chemical
Food & drinks ...

Brochure: Ref. 608
Catalogue: Ref. 607



■ PULP & PAPER

Chippers
Calenders
Winders
Pumps ...

Brochure: Ref. 609
Catalogue: Ref. 233



■ PEOPLE TRANSPORT

Brochure: Ref. 619
Detailed information: refer to factory

a complete

product portfolio



HELICAL AND BEVEL GEARED MOTORS

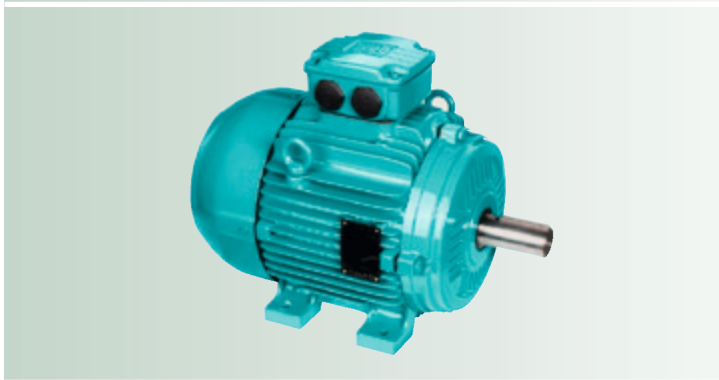

ELECTRIC MOTORS

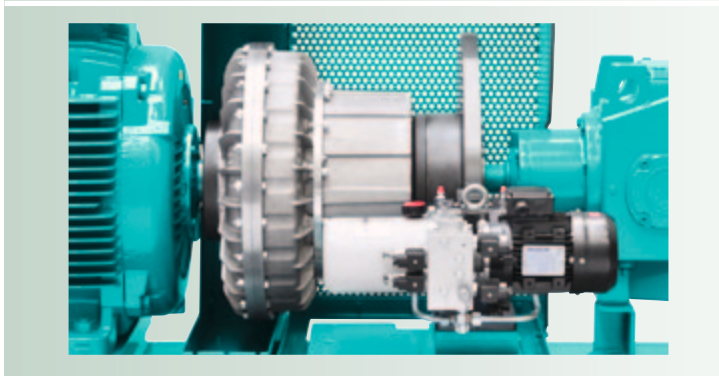

COUPLINGS

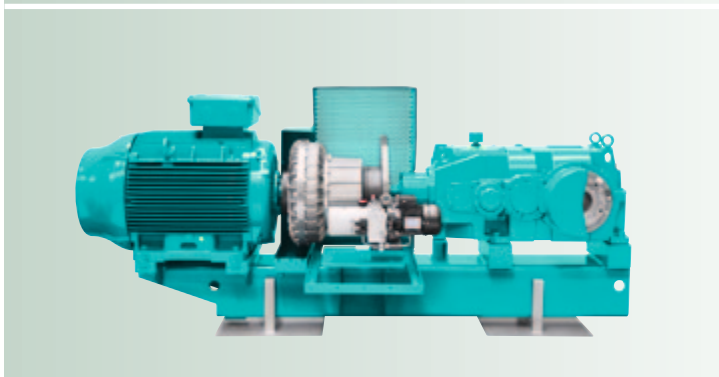

BRAKING SYSTEMS

complete

the right combination for



■ ONE STOP SHOPPING: YOUR ADVANTAGES

The ideal win-win relation

- Focus on your core business and area of expertise
- Simplify engineering, assembly and maintenance processes
- Elements of the drive package are designed to suit your application

Product and supplier reliability

- Total project solutions from one supplier

- A single warranty and a worldwide service network for the whole package avoid buck passing between suppliers
- All products are designed for easy maintenance

Improved cost effectiveness

- One stop shopping reduces purchasing costs
- Correct component sizing cuts operation costs
- Optimum design and matching saves assembly time and expense

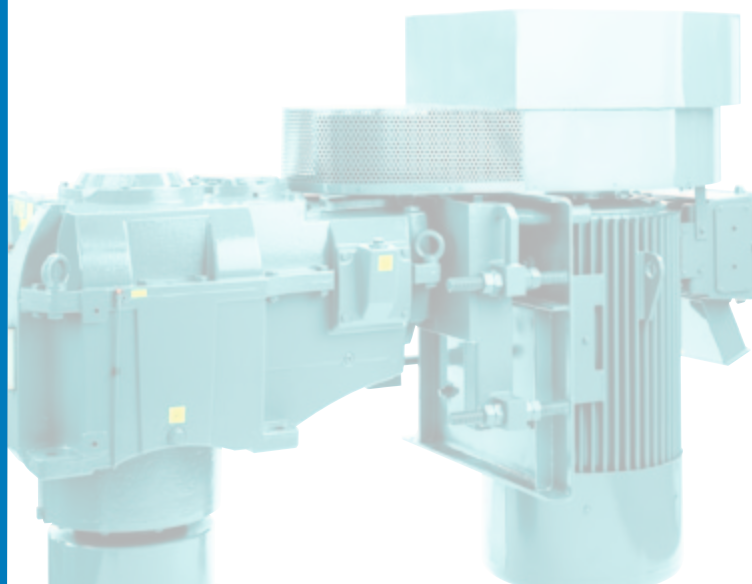
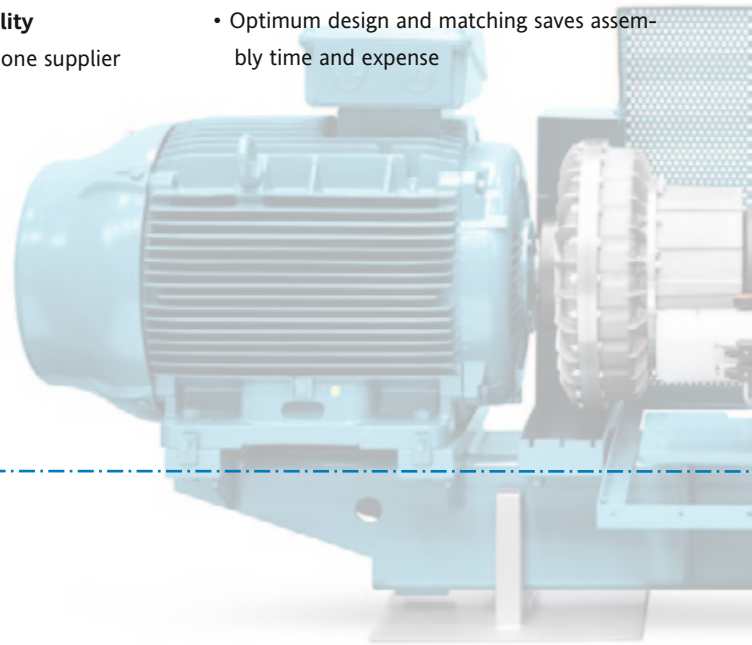

Close partnerships with several world-class suppliers for motors, couplings, brakes, instrumentation, bearings, pumps, etc. enable us to offer complete drive solutions.

drive packages

your application

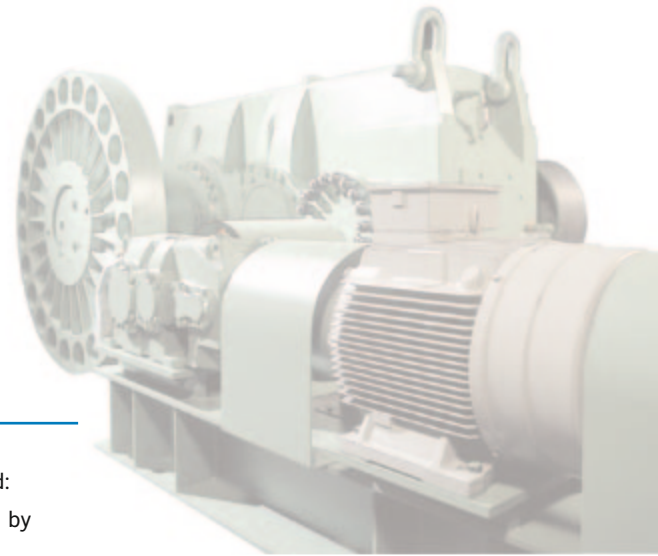

■ HORIZONTAL CONFIGURATION

Frequently used in conveyor systems, mill drives, extruders, pumps and various material handling operations, horizontal drive packages consist of a parallel or right-angle gear unit, input and output coupling and an electric motor, mounted on a common bed or base plate. Other configurations are also offered, which include lantern housings for flange motors, hydraulic couplings, V-belt transmissions, etc. ...

Additional features can be incorporated:

- The electric motor can be controlled by a frequency inverter.
- An auxiliary drive may include an in-line or right-angle geared motor, which is connected to the main gear unit by chain, free-wheel or clutch coupling.
- Disc or drum brakes can be easily added.
- The drive package can be foot- or shaft mounted, using a hollow shaft or a flange coupling.

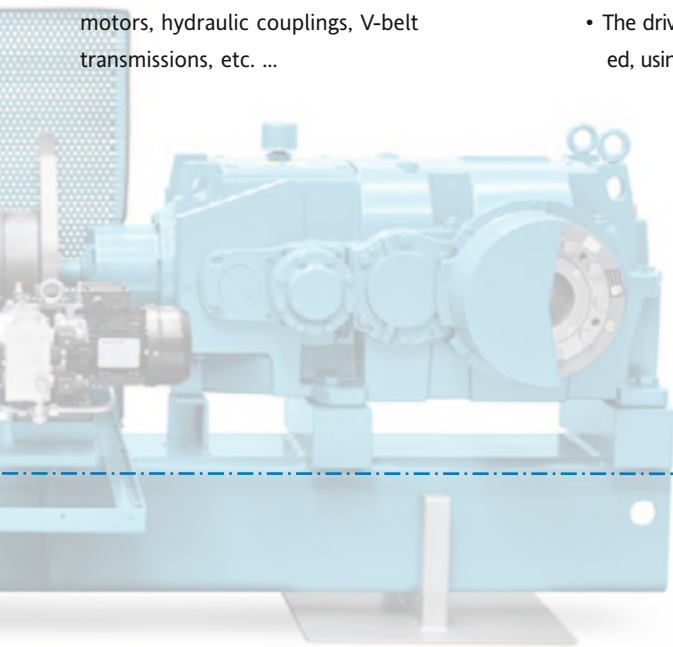

■ VERTICAL CONFIGURATION

Many applications will require a configuration with a vertical output shaft. Examples can be found in mixers and agitators, surface aerators, etc. ...

A typical vertical drive package consists of a parallel gear unit fitted with a lantern housing to accommodate a flange motor, a flexible input coupling and a rigid flange output coupling. Other configurations include:

- Standard gear units with increased bearing span or a variety of optional bearing/output shaft arrangements to absorb a wide range of external loads.
- Designs with hollow output shaft arrangements, V-belt connections between the motor and the input shaft of the gear unit and variable speed drives, either electronic or mechanical.

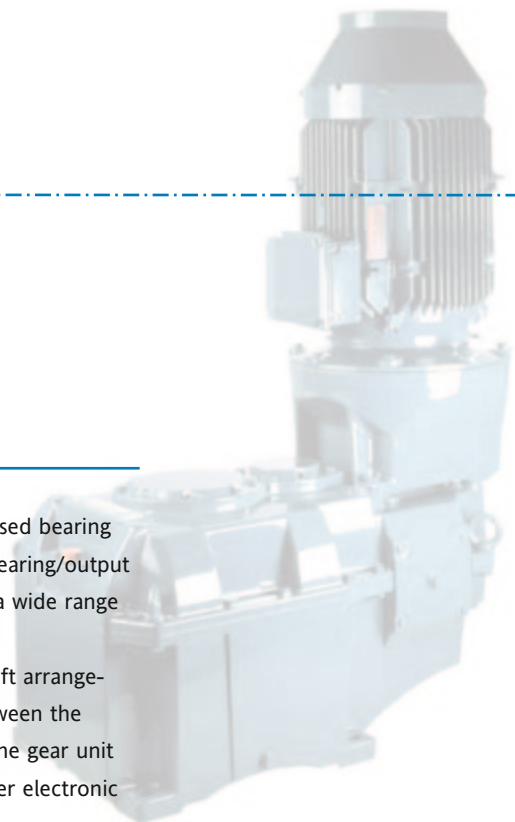



production

Advanced production technology

Hansen Industrial Transmissions' position as a world leading company is built on the highest production standards. Our core manufacturing activities are the production of gears and gear housings. Investing in technology and machinery has allowed the succession of quality products. Attention to production standards begins with in-house expertise that ensures the quality of raw materials such as cast iron and steel. Further quality assurance includes state-of-the-art in-house technology for heat treatment, gear grinding and machining of housings. Efficiency and cost of the working methods are systematically re-evaluated. The factory makes full use of the CAD/CAM flexible manufacturing systems and the latest in CNC machinery for top-notch productivity.

Both employee and system flexibility are integral to productivity. Highly skilled machine operators can run a variety of machines, depending on the customers' orders and workload. Employee training is strongly emphasised and concentrates on lean manufacturing, implementing:

- Total Productive Maintenance (TPM) to increase the availability of machinery;
- Single Minute Exchange of Dies (SMED) to decrease set up times;
- Six Sigma to ensure faultless manufacturing processes;
- Kanbans to adjust product flow to current demand;
- 5 S programmes to monitor work efficiency and cleanliness.

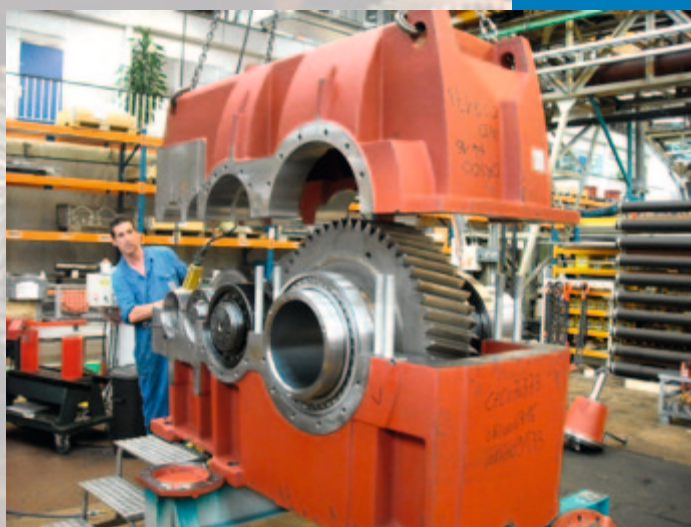



services

For professional support

Hansen Industrial Transmissions Sales and Engineering Centres are located on every continent. The international standards implemented at these centres are your assurance of consistent engineering expertise - a key asset in international projects.

For technical support

Our experienced service engineers are highly qualified to evaluate problems and recommend the best solutions. Round the clock production requires round the clock support. Our service engineers are on standby 24 hours a day at our Service Centres around the world - 7 days a week, 365 days a year!

For expert training

Hansen Industrial Transmissions can conduct customer service training programmes at its Service Centres or at a customer's own site if requested.



tel. +32(0)3 450 12 34
fax +32(0)3 450 15 99

www.hansenindustrialgearboxes.com/services
services@hansenindustrialgearboxes.com



a standard of

quality



Quality throughout

Every aspect of our activities, starting with our system operators, is impregnated by a total commitment to quality. The production process itself means another quality guarantee.

The production units use the most reliable manufacturing techniques available, including precise NC boring of housings, case carburising of all gears (the most reliable heat treatment) and gear grinding with the latest machinery.

Both gear & housing manufacturing dispose of a fully equipped and climatised test lab.

Inhouse test facilities are used for load testing and measuring.

Fully committed to total quality assurance, Hansen Industrial Transmission was in 1991 the first in its industry to receive the ISO 9001 certificate for its quality management system.

what differentiates us

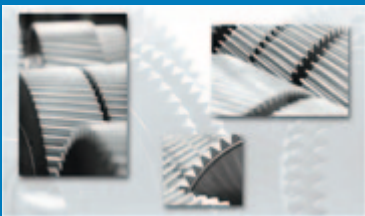

- Focus on Industrial Gear Units
- Application oriented product range
 - 2 different housings for vertical and horizontal applications
 - large number of options available to adapt standard unit to the requests of a specific application
 - Dedicated gear units to exactly match application specification
 - Best in class on low noise and vibration behaviour
 - Long life cycle
- Engineered to order – philosophy, each order treated as „unique“
- Service friendly product concepts
 - Split housing for Hansen P4 – always
 - Unique Oil-Lock™ for maintenance free high speed sealing
 - Drywell system for leak-free operation
- Complete solutions by offering drive packages :
 - strong partnerships with first class suppliers of motors, couplings, brakes, ...

Structured and organized to support project business

- Documentation
- Quality plans, Certificates
- Witness tests
- Customer inspections
- Global network with fast links between local organisations
 - No internal competition, customer oriented organisation
 - Continuous exchange of information and worldwide coöperation
- World wide Service Network
 - Europe: own service facilities + authorized service partners
 - Global: assembly centres + partners
- In-house R&D and manufacturing
 - Excellent technical know-how
 - Able to make „specials“ – customized gear units
 - High quality awareness throughout the organisation
- Familiar with project business, using the required tools
 - Philosophy of customer support, from early stages of a project
 - For both technical and commercial aspects
- Advisory selling – high level of technical skills
 - Technical expertise
 - Application skills
 - Being able to advise and give technical support immediately
 - Specification reviews, deviation lists if needed
- Having the right tools
 - Calculation software for the complete gear unit
 - Mechanical and thermal selections
- High quality of quotations
 - Complete descriptions
 - Transparent
 - Fast reaction time because of skilled people and „do it yourself“ approach

Hansen Industrial Transmissions commits to be a pioneering innovator. The production of high performance gear units stems from an interactive partnership with our clients, the end users and the actively engaged manpower of our global enterprise. Embracing design, manufacturing and customer services, the company has grown into a world leader in its field. Today, we set standards for both product and working environment, inciting a knowing environment to seize all new and inspiring technologies.



Hansen Industrial Transmissions nv
Leonardo da Vincilaan 1
2650 Edegem - Antwerp
Belgium

www.hansenindustrialgearboxes.com
info@hansenindustrialgearboxes.com

tel. +32(0)3 450 12 11
fax +32(0)3 450 12 20

See our worldwide
sales & service network at
www.hansenindustrialgearboxes.com